



Hardware specifications

Feather Shape Assembled dimensions 5600mm (h) x 1050mm (w) approx

Quill Shape Assembled dimensions 5800mm (h) x 1350mm (w) approx

weight 3.1kg

Graphic specifications

Recommended substrate:

Lightweight flag textile

Recommended print process:

Dye-sublimation print onto one side of the flag only

Visual size & graphic dimensions:

Refer to template:

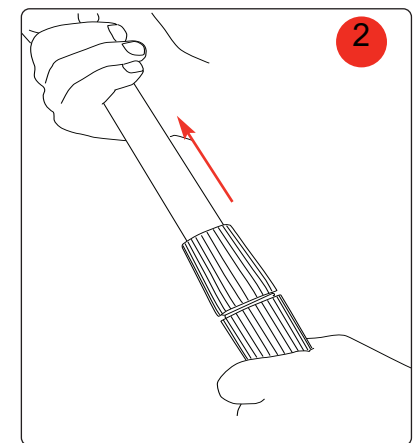
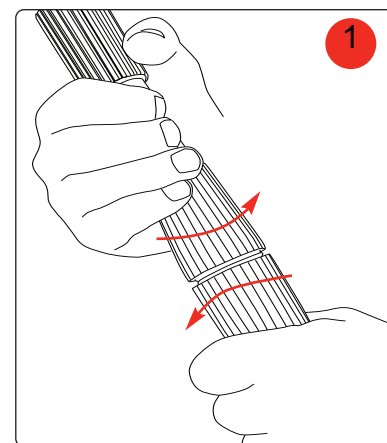
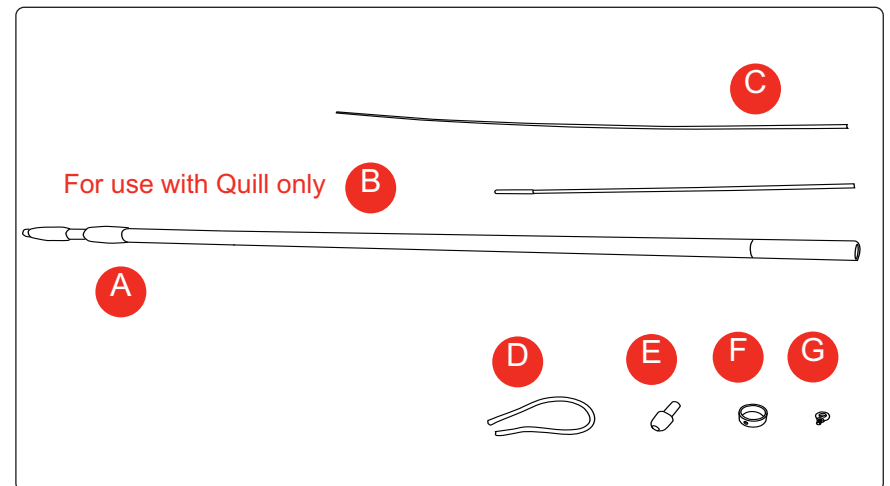

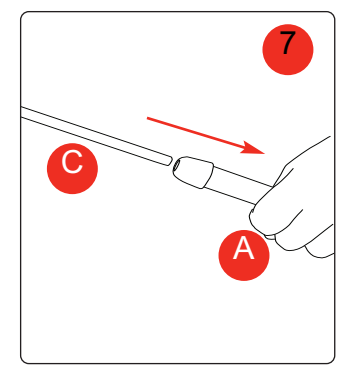
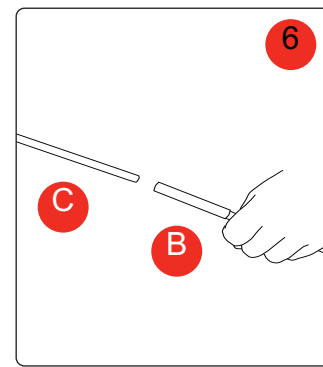
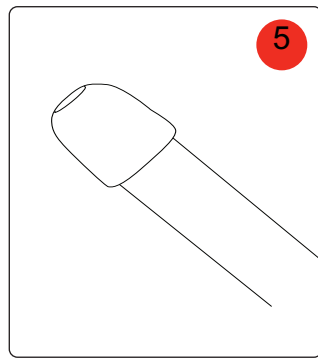
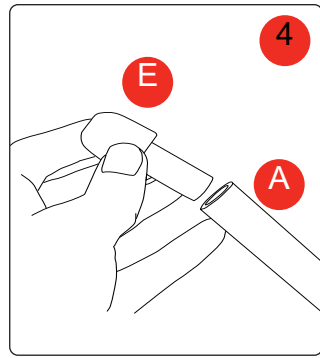
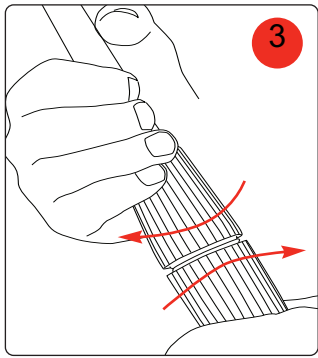

Attaching Graphic

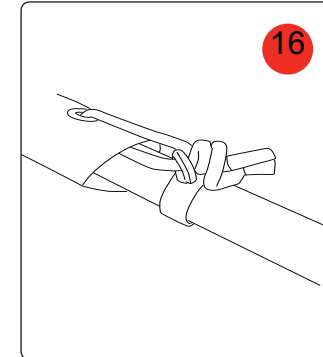
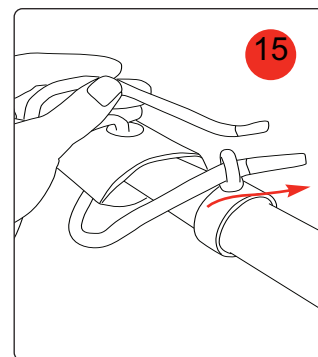
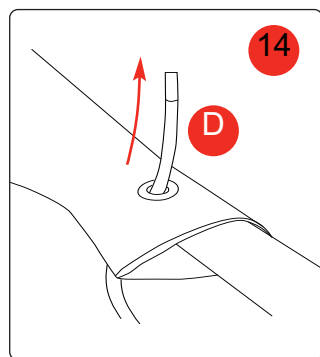
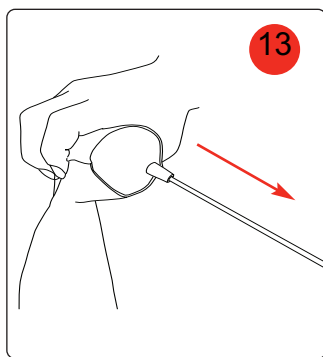
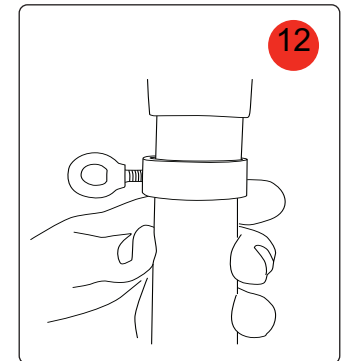
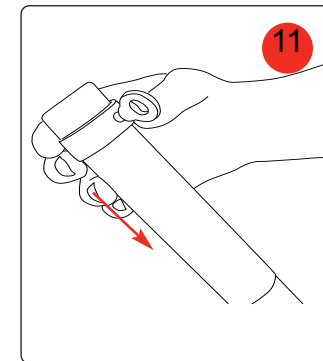
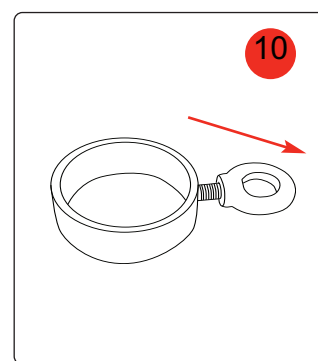
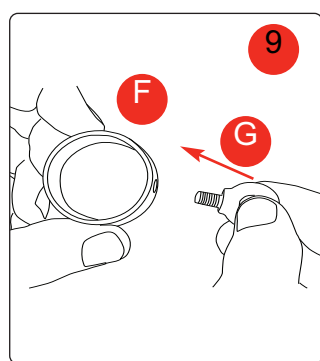
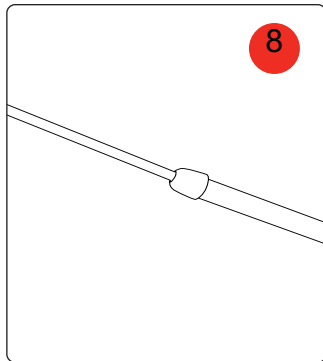

Please note: For the Zoom Grande Feather shape skip step 6.

Base Assembly

